



## ***D50: Advances in Software Engineering Analysis Model***

***Wolfgang Emmerich***

© Wolfgang Emmerich, 1998/99

1

- Last week, we have started to look at Ivar Jacobson's object-oriented software engineering method. We have seen how use cases model the different ways that actors interact with a system.
- We have also seen examples of type/instance relationships. One use case models different similar interactions between actors and the system. We referred to as instances of use cases as scenarios. Moreover we have separated actors and users. Again an actor identifies the type for multiple similar users.
- The purpose of this lecture is to discuss the Analysis Model. More precisely we are going to discuss the question: *What constitutes the Analysis Model and how is the result of the Requirements Model transformed into the Analysis model?*



## *Lecture Overview*

- *Aims of Analysis Model*
- *Building on outputs of Requirements Model*
- *Basic UML notations*
- *Introduction of new types of analysis objects*
- *Reuse of use cases*
- *Inputs for Design Model*

© Wolfgang Emmerich, 1998/99

2

- The lecture begins by placing the analysis model in the theoretical context of Jacobson's overall view and then building on the outputs from the requirements model stage as the inputs for the next steps in production.
- We will then introduce basic UML notations for classes and object etc. in order to provide the means for representing classes and objects defined in the requirements model in order to refine them in the analysis model.
- It is then possible to introduce the roles of different types of classes identified by Jacobson (interface, entity and control). The separation of these roles supports and simplifies the successive modelling of classes in the design phase and makes the analysis model more expressive.
- The use cases are used, and refined, as a means to guide, and evaluate the analysis work. This is done by tracking the descriptions of each use case to the influence it had on specifications of classes and objects.
- The cumulative generation of outputs (i.e. the enriched use cases and the class diagrams) provide the inputs for the design model, the first part of the 'construction phase' which is subject of lectures 5 and 6.
- Let us now use the overview picture of last week to review where we are...



## Stages of Development Process

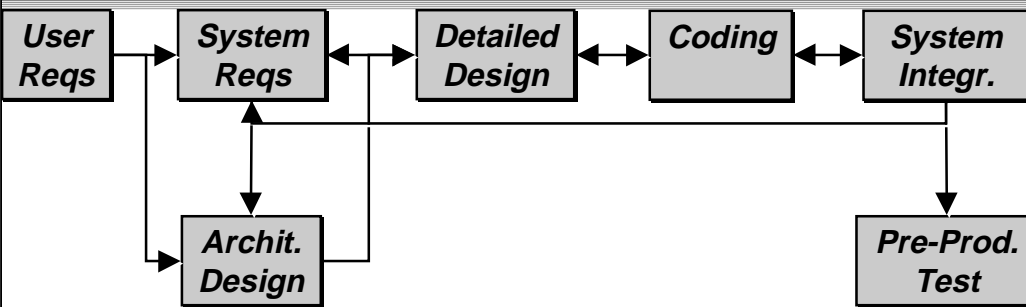

<b>Project and Risk Management</b>
<b>System Management</b>
<b>Version and Configuration Management</b>
<b>Quality Management</b>



# System Reqs Document

**Owner: Chief Business Analyst**

**1 UML Use Case Model (Rose) +**

**2 UML Interaction Diagrams (Rose) +**

- UML Sequence Diagrams

- UML Collaboration Diagrams

**3 UML Analysis Class Diagram (Rose) +**

**4 User Interface Prototypes (GUI Tools, Office) \***

**5 Specification of Report Format (Office)**

**6 User Manual (Office)**

- User Reference Manual

- User's Guide

} **Analysis Model**



## ***Aims of the Analysis***

- ***To provide a ‘logical model’ of the system, in terms of :***
  - ***classes,***
  - ***relationships***
  
- ***“How to get the thing right, now and in the future “***

© Wolfgang Emmerich, 1998/99

5

- The production of the analysis model is a vital step in the formalisation of the system. While the use case model identified sequences of events and interactions between actors and the system will the analysis model specify the classes of objects that actually occur in the system. There are no fixed rules for such a transformation. There is only guidance in the form of more or less detailed conventions.
- The essential first step is the definition of those classes that specify properties of objects that need to be present in the system and the relationship between them. This will show the ‘logic’ behind the system, a model that is a representation of structure that is reasoned correctly.
- Having identified the characteristics of the ‘right thing’, defined specifically in terms of the use case model (and any other specific requirements documents relating to the environment etc.), we must prepare a logical model which will remain fixed and will not be altered in subsequent design and implementation stages.
- From a practical point of view will build on outputs from the requirements model using a further sequence of steps (Nos 10-15) that are detailed on the next slide...



## *Producing an Analysis Model*

- ***Inputs***
- ***Actions***
  - 10 Draft initial class diagram***
  - 11 Re-examine use case and object behaviour***
  - 12 Refine class diagram***
  - 13 Execute check***
  - 14 Revise class diagram***
  - 15 Group classes into packages***
- ***Outputs***
- ***Notations***

© Wolfgang Emmerich, 1998/99

6

- The production of the analysis model begins with the elaboration of the problem domain objects into the initial class diagram. In this step, we will take commonalities between similar domain objects into account and model them as classes. We will also try to identify commonalities between different classes and identify these as generalisation and specialisation relationships.
- The first step develops a draft class diagram. It is followed by a re-examination of use cases in order to prepare for modelling the necessary behaviour of objects in a way that they reflect the use cases.
- We then refine the class diagram so that it reflects the behaviour of the use cases. In order to do this we map actions mentioned in the use case into operations of some classes and model use case state information as attributes of classes.
- We then validate that every information provided in the use cases has been considered in the class diagram.
- If necessary we revise the class diagram in order to avoid losing information from the use case diagrams.
- The grouping of classes into packages is not only an analysis modelling activity, it is also an essential managerial step to keep the development process manageable. The suggestion to perform the packaging step at the end will only work for very small scale projects. Depending on the scale of the project it might be necessary to develop the class diagram in a packaged form and revisit the packaging whenever the class diagram is to be revised.
- Let us now consider the inputs and outputs of the analysis phase on the next slide...



## ***Analysis Input and Outputs***

### ■ ***Inputs:***

- ***uses cases and use case model***
- ***problem domain object list***

### ■ ***Outputs:***

- ***class roles and responsibilities [text]***
- ***use case description in terms of classes and operations [text x use case]***
- ***completed analysis model [class and package diagrams]***

© Wolfgang Emmerich, 1998/99

7

- The most important input of the analysis phase are the use cases and the use case model produced in the requirements phase. Also we take the list of problem domain objects produced at the end of the analysis phase as a starting point for the definition of the class diagram.
- The most relevant output of this phase is the class diagram that reflects the attributes, operations and relationships between the classes that represent the objects occurring in the use case. The class diagram will be structured into different packages that contain classes with a high internal coupling.
- In addition, the check that the behaviour of textual use case descriptions has been properly reflected in the class diagram will produce use case diagrams in terms of classes and their relationships. On the other side it will identify for each class the different roles that the class will play with respect to the use cases. In that way bi-directional traceability is provided that will simplify completeness and change impact analysis.
- The first step of the transfer from the requirements model to a logical analysis model is the production of an initial class diagram. This requires the use of standard UML notation, the first being the class that is detailed on the next slide...



## ***Notations***

- ***Class (rectangle containing name, attributes, operations)***
- ***Object (rectangle plus obx:Cx)***
- ***Association (by value/aggregation, cardinality/multiplicity)***
- ***Generalisation (UML term replacing OOSE 'inheritance')***
- ***Package***
- ***Depends association***





## CLASSES IN UML

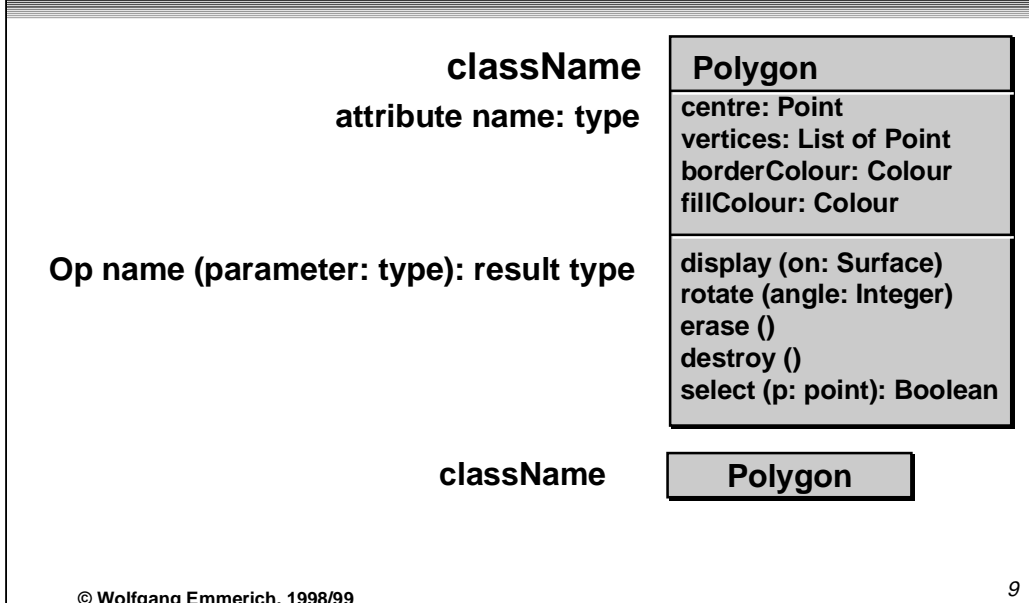

© Wolfgang Emmerich, 1998/99

9

- We have introduced the concept of classes in Lecture 2 (see 2.14, 2.15). In essence, a class defines the common properties of objects. These are attributes, relationships and operations.
- This slide now presents the UML notations for classes. Can be declared in two different ways, depending on the level of detail that needs to be defined/shown. The simplest form is just a solid-outline rectangular box with a character string inside. The character string is the class name. It usually has to be unique within a given scope to avoid ambiguities.
- In the more complex form the rectangle is divided into three compartments. The class name is given in the top compartment. The second defines a list of attributes and the third defines a list of operations.
- An attribute name is provided for each attributes. Names should be unique within the scope of the class. Attribute types and initial attribute values can be defined as an option.
- Operations are defined by operation name. Whether or not operation names should be unique is a matter of taste and depends on the target programming language. If the languages do not support overloading it is advisable to refrain from defining operations that have the same name. Again parameter lists and result types can be defined as an option.
- Objects are instances of classes. Sometimes it is necessary to identify individual objects, for instance if individual objects serve a particular purpose. The next slide outlines the representation for objects...



## Objects in UML

objectName: className

attribute name: type = value

(same operations  
for all instances  
of a class)

objectName: className

triangle1: Polygon

centre = (0,0)  
vertices = (0,0), (4,0), (4,3)  
borderColour: black  
fillColour: white

display (on: Surface)  
rotate (angle: Integer)  
erase ()  
destroy ()  
select (p: point): Boolean

triangle1: Polygon

© Wolfgang Emmerich, 1998/99

10

- Again the idea of object has been discussed in Lecture 2 (see 2.16)
- The UML defines the notation for objects as follows: "An object is drawn as a rectangle with an underlined name of the object name and its class name (separated by a colon)."
- "It may be divided into two compartments. The top compartment contains a string in the format: objectName: classname."
- Unlike classes, objects have a particular state that is characterised by the value of the object's attributes. Note that in the presence of inheritance the object inherits attributes from all its super classes. The UML defines the notation for attribute values as follows: "The bottom compartment contains a list of attribute values in the format: attributeName: type = value. The type is usually omitted since it can be determined from the class itself as well as the form of the value but it may be included for clarity if needed. The attribute name must match one from the class."
- Note that it is unnecessary to determine the operations. These can be inferred from the declaration of the class of which the object is an instance. The object would be overspecified if we defined operations redundantly.
- Having identified a variety of classes, the analysis must go on to consider their common characteristics, the issue of inheritance or 'generalisation' as it is called in UML. The notation for generalisation is outlined on the next slide...

## UML Generalization

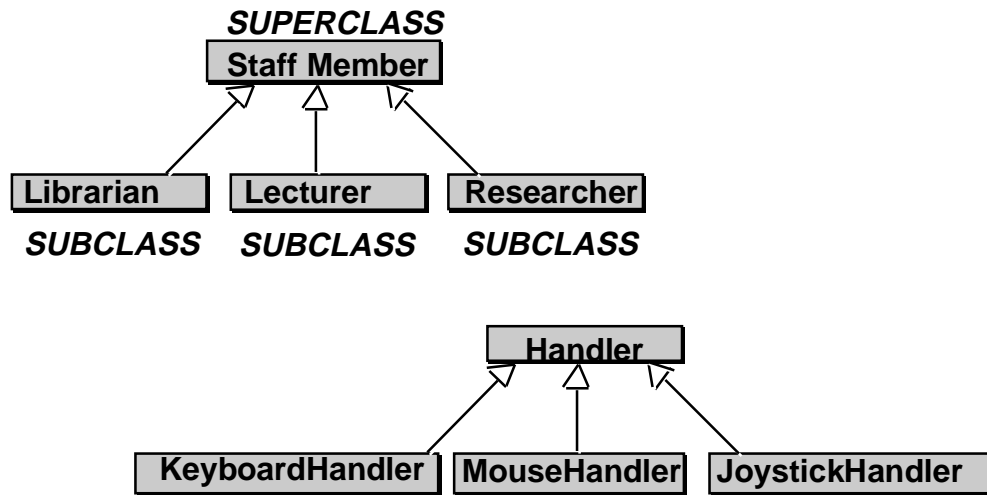

- The concept of inheritance was introduced in Lecture 2 (see 2.18 and 2.19). We now present the UML language constructs for it.
- In UML ‘generalisation’ is used as a replacement, or synonym, for ‘inheritance’ in OOSE, but UML documents still refer to ‘inheritance’ (“Inheritance is a taxonomic relationship between a superclass and its subclasses. It is often called generalisation or specialisation depending on whether one is going from subclass to super class or from superclass to subclass. ... All attributes, operations and associations are inherited by all subclasses.”)
- Inheritance is defined in the class diagram as “a directed line with a closed, unfilled triangular arrowhead at the superclass end” (UML V0.91 p7).
- The UML accommodates multiple inheritance (see 2.20). The number of arrows that may start at a class is, therefore, not limited to one.
- Inheritance (‘generalisation’) is one of the two types of relationships which are extensively used in any analysis model / initial class diagram; the other relationship is that of association that we detail on the next slide...

## Associations in UML

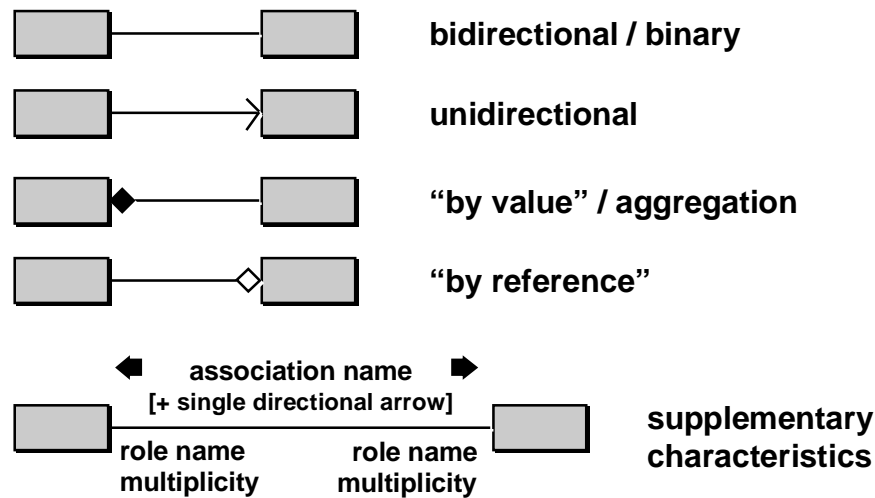

- Associations represent structural relationships between objects of different classes, representing information that must be preserved for some duration.
- Bidirectional associations are traversable in both directions. It is the least explicit association and most common at early stages of analysis. Bidirectional associations are usually refined during the course of the analysis by giving it an aggregation or reference semantics, identifying different multiplicities and by making the roles explicit that the connected classes play in the association.
- Unidirectional associations imply that the implementation should make it straightforward to navigate from a source object to a target object across the association. Unidirectional associations are regularly implemented by pointer type instance variables.
- Aggregation implies that instances of one class are embedded within instances of another class. The instances therefore form composite objects; ‘by reference’ relationships are used to refer to other objects.
- An association may have a name with an optional small “direction arrow” showing which way it is read, e.g. employer employs > employee.
- As an attribute of a role, multiplicity shows how many instances of the attached class may be associated with a single instance of the object at the other end of the association. ‘\*’ is used for “none to many”.
- Associations are an extremely powerful concept that can be elaborated and used in many ways as the following examples suggest...



## Association Examples in UML

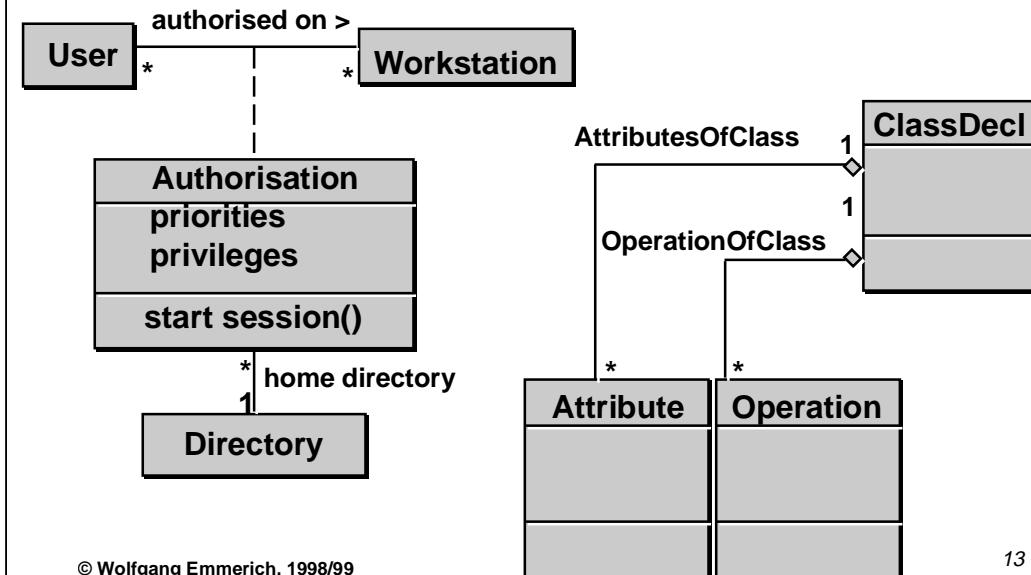

- In the relational data model relationships can have attributes in order to characterise properties of relationships. For the same reason, associations in the UML can have specific properties by attaching a class to them. The object-oriented approach is even more powerful than the relational approach because properties of associations may not only be attributes, but also operations and other relationships. The 'association class' is represented by a class rectangle attached by a dashed line to the main link, as shown in left-hand example.
- In the example, the 'authorised\_on' relationship has attributes that identify the priorities and privileges that go with the authorisation and an operation that is used to check the authorisation during the startup of a session. The 'association class' also has an association that identifies the home directory for each potential authorisation record. Assuming that the user has the same home directory on every workstation the multiplicity of this association is many to one.
- The right hand diagram shows a very small segment of the UML 'meta model'. The purpose of the meta model is to the notation itself to identify how the notation is structured. This example represents the class of objects containing all class object declarations.
- Now that we know all the ingredients we can start modelling a class diagram ...



## ***Class Diagrams in UML***

### ■ ***Class diagrams :***

- ***show logical, static structure of system***
- ***provide core of 'unified model'***

### ■ ***Generation of initial class diagram from problem domain object list***

- ***classes of objects***
- ***associations / attributes***
- ***inheritance relationships***

© Wolfgang Emmerich, 1998/99

14

- The purpose of a class diagram is to provide a generic description of possible system states. This is done in a class diagram by modelling classes that describe the common static properties of similar domain objects.
- At this stage of modelling we are only concerned with identifying the attributes of classes and to analyse similarities in order to identify generalisation relationships.
- Please note that class diagrams describe the system from a type level perspective. They are, therefore, not concerned with particular objects that are instances of classes.
- Class diagram provides a single, albeit essential, view of a system. The class diagram is the core of the UML and other views organised according to the class diagram. The other views are provided by: use case model (3.13) sequence diagram showing interaction between set of objects (part of design model) and state diagram showing temporal evolution of an object of a given class (also part of design model).
- We are now in a position to attempt the first stage in the production of the analysis model (10 on 4.5) using the output from the requirements model as input...



## A 'Recycling Machine' Class Diagram

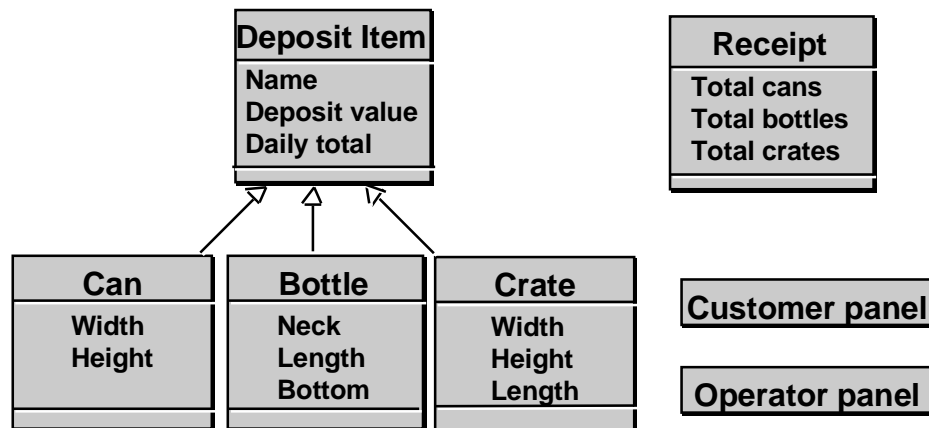

© Wolfgang Emmerich, 1998/99

15

- This slide depicts the initial class diagram that we have derived from the use case descriptions of the recycling machine example. This is how we got there:
- We have started from the list of domain objects produced as part of the requirements model and have drawn a class representation for each of the items.
- After that, we have assigned different domain attributes in order to model states of real world objects.
- When we had identified the attributes of classes, we recognised that cans, bottles and crates have several attributes in common. In order to avoid this duplication we have done a generalisation and created the class 'Deposit Item', declared these attributes for Deposit Item and then introduced the generalisation relationship.
- Note that it need not be done this way around. We could also have spotted an abstract class for deposit item, declared the attributes and then introduced the generalisation relationship.
- As a first plausibility check we can see whether every attribute defined in a generalised class makes sense in every single subclass.
- Note that the class diagram produced now is far from being complete. Operation specifications are missing. Also the class diagram represents one of any number of alternatives, e.g. to define a class of objects which contain dimensional measurements for any recycleable item, or alter 'Deposit Item' to include these.
- The question that arises now is how do we proceed to improve such a draft diagram? The clue is that we have essential output from the requirements model stage, the use cases...



## Exploiting Use Cases

- ***Employ classes and use cases, one by one,***
  - *to describe roles and responsibilities of each class*
  - *to distribute behaviour specified in use cases*
  - *to ensure that there is a for every behaviour*

- In order to complete and refine the class diagram we employ the use cases and the list of domain objects that have been generated as part of the requirements model.
- We take each single use case and describe for each class contained in the initial class diagram the role and the responsibility of the class in a textual description. This exercise will result in the first analysis model output in form of textual description of each object's role and responsibilities.
- We then distribute the behaviour that we have identified in the use cases by assigning operations to objects. We will have to make sure that each behavioural description is covered by an operation.
- At the later design stage it might become necessary to delegate operations to other classes but we do not worry about this during the analysis stage.
- Also this exercise is likely to result in a proliferation of odd classes, e.g. receipt printer, alarm device, bottle slot. Consequently we need some means of differentiating the purpose of system elements that have been identified.
- Jacobson provides a categorisation of classes which is a useful aid to analysis. He suggests three different categories according to the roles that classes can play. The next slide details these roles of classes...





## Roles of Classes in OOSE

- **Interface classes - for everything concerned with system interfaces**
- **Entity classes - for persistent information and behaviour coupled to it**
- **Control classes - for functionality not normally tied to other classes**

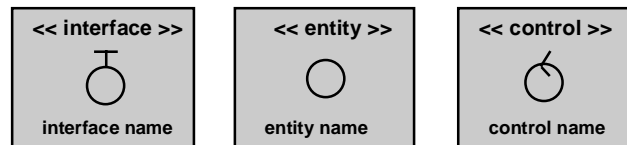

- **Integrated into UML as stereotypes:**

© Wolfgang Emmerich, 1998/99

17

- Actors use the system's interface to interact with a system. The actors can be people using the system or other systems for the exchange of information. People would need to interact through a user interface with the system and likewise other systems need an interface. Jacobson suggests to denote classes defining the operations that are available at a user or a system interface as interface classes.
- Other classes store information and object states in attributes. These classes would be considered as entity classes according to Jacobson's taxonomy.
- Control objects are the most 'fuzzy' category. They are required to contain operations coordinating the interaction with other objects, the computation and result delivery e.g. to calculate value of recycled items. Typically a control object contains functionality unique to one or a few use cases.
- Stereotypes provide meta classifications of elements in UML and an iconised representation for them. Stereotypes add information about a class that is exploited in the design stage. Interface classes, for instance, need to be designed in a way that their instances can be accessed from distributed objects (these are objects running on other machines). A particular stereotype is named at the top of the box between double arrows. In its simplest form (as used by Jacobson) the icon and the class name are sufficient.
- Note, that this is a 'shorthand version' for a complete definition of a class, but not a permanent substitute.
- Now we consider these roles of classes in greater detail...

## Interface Classes

- **Contain functionality directly dependant on system environment**
- **Definitions focus on interaction between actors and use cases**

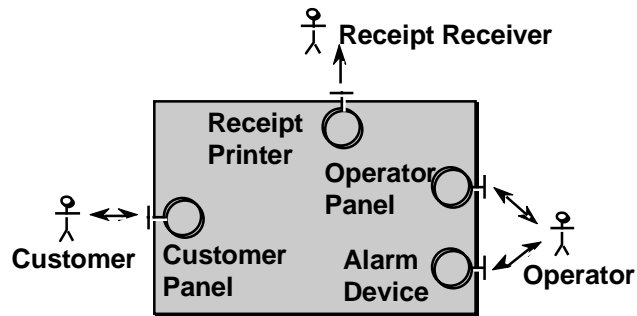

© Wolfgang Emmerich, 1998/99

18

- An important concern in the integration of complex system is to make sure that the systems remain well separated. It is therefore undesirable to have one system accessing the operations of another system directly. This would violate the important principle of information hiding. The systems should rather be interconnected through connectors which can isolate the systems from each other. Interface classes do fulfill this purpose.
- Interface classes provide also a chance to the system analyst to make clear system boundary and declare all the interfaces provided across it. As part of the interface specification, interactions that the system can have with its actors are specified. Recall that actors can be human users as well as other systems.
- The interactions we are concerned with at the system interface level include
  - issuing a request to an actor,
  - providing information for an actor,
  - receiving a request from an actor, and
  - obtaining information from an actor.
- It is possible to represent each interface class as a 'plain' UML class box. However, an explicit diagram like this where classes are represented using there stereotypical representations emphasises the essential dependency relationships across the system boundary, an important information to have during a later design.

- *Definition of both dynamic*
- *and static associations*

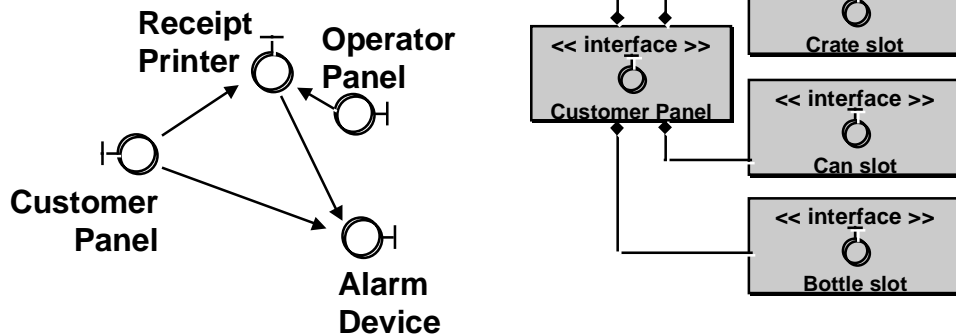

- In order to enable interface objects to send a message to another interface object the interface objects need to be associated with each other and we use UML associations for that purpose.
- In OOSE the simplest form of binary association is static and given the name 'acquaintance'. This would be appropriate to describe, in most general way, the relationships in the left hand diagram. However, we can already be more explicit and identify these associations as being both dynamic and unidirectional, so have used the arrowed line notation introduced earlier (confer page 4-10).
- The right-hand side displays an aggregation association between interface classes. This again is a regular pattern as complex user interfaces tend to be composed of simpler objects. In the example the aggregation corresponds to the composition of the user interface of the recycling machine.
- We could have even add further information to all these associations eg names on left and multiplicity on right.
- Interface objects are not designed to contain information; this is the principle role of the entity object as we will see on the next slide...

## Attributes of Entity Classes

### ■ Purposes of entity classes :

- To store information persisting after completion of a use case
- To define behaviour for manipulating this information

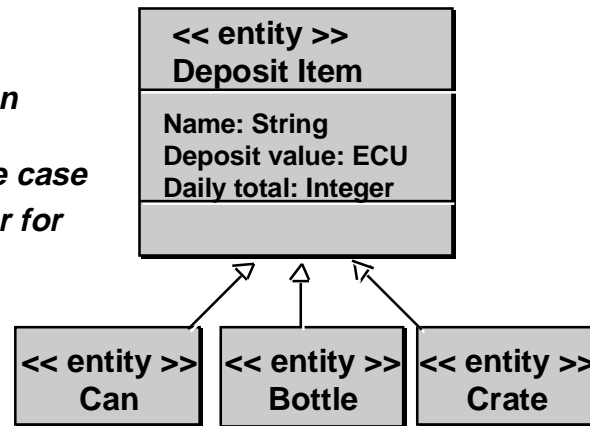

- The classes modelling the domain objects that were part of the list produced at the end of the requirements stage will be classified as entity classes.
- Entity classes typically have attributes that are capable of storing information. As class diagrams are at type level, we are not concerned about actual attribute values. Only objects that have been instantiated from the class have different attribute values.
- This diagram shows the next stage of elaboration of classes to include attribute types. The typing of attributes restricts the domain that the value of these attributes can have in objects instantiated from the class.
- The domain might even further be restricted but this restriction is usually implemented by operations.
- A negative daily total value would not make sense for instantiations of any deposit item. This, so called, integrity constraint is then implemented by operations that would not allow the assignment of negative values to the attribute.
- Hence the next step to consider is the behavioural specification for classes (the third compartment). This is dictated by operations and messages that are sent between objects in order to invoke the operations.

## Entity Communication

- **A primary task to identify associations involving communication**
  - **modelling of communication between objects**
  - **shows the sending and receiving of messages as stimuli**
  - **starts from object initiating communication**
  - **directed to object where reply generated or operation executed**



- In order to be able to send a message to an object the requesting object has to know the identity of the object. One way to obtain the identity is to traverse along an association.
- These associations need to be defined in the class diagram. Associations that are used purely for message passing purposes tend to be directed because they need to be traversed from the sender in order to identify the receiver.
- The diagram shows such a <<communication >> association between a class for recording a customer's returns and class recording daily totals.
- The definition of associations provides the basis for completing the definition of operations as discussed on the next slide...



## Entity Operations

### ■ *Defining entity operations for:*

- *storing and fetching information*
- *creating and removing object*
- *behaviour that must change if entity object is changed*

**<< entity >>  
Deposit Item**

**Name: String  
Deposit value: ECU  
Daily total: Integer**

**Create ()  
setValue (integer)  
Increment ()**

© Wolfgang Emmerich, 1998/99

22

- Operations provided by entity classes are defined for the above purposes.
- Operations that store information typically check integrity constraints of the object (e.g. to make sure that the daily total value does not become negative and that positive values are added only). Operations defining the fetching of information typically check access rights of the principal requesting the information before providing it.
- Special operations define the creation and removal of objects. An operation that creates a new object by instantiating a class is referred to as a constructor while the operation that removes an existing object is referred to as a destructor. Constructors typically perform attribute initialisations and destructors release storage space occupied by the object.
- Other operations may be provided in order to implement different state transitions that objects of the specified class might be involved in.
- In general operations are used in order to hide object states that should not be exposed to other objects. This contributes to the principle of information hiding (though on a finer level of granularity than interface classes) (for a discussion of information hiding refer to slides 2-12 and 2-13)
- Note that Jacobson's OOSE method does not consider it to be essential to define specific operations at the analysis stage.
- Now we discuss the third role that classes can play, which is the least clear defined...

## Control Classes

### ■ Control classes needed to provide for:

- *behaviour not natural in interface and entity classes*
- *'glue' between other classes in use case*
- *typical control behaviours*
- *improved maintainability*

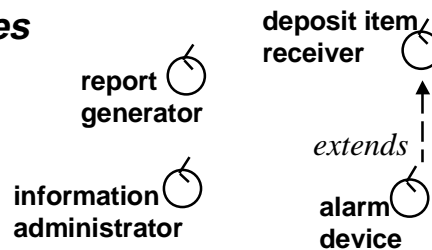

- Even in object-oriented decompositions of systems, there is sometimes a need for accommodating functions in order to model behaviour that does not directly relate to properties of objects. This behaviour is modelled as operations of classes that are control classes.
- Control classes provide the glue between interface classes and entity classes. To construct stable systems in the real world, one should not use too much glue but only use it to fill the gaps between components. This is the same with object-oriented modelling. Control classes should be deployed with care.
- Control classes should be used to represent use cases involve some form of coordination operation, such as
  - transaction-related behaviour,
  - specific control sequences, and
  - functions separating interface and entity objects
- The algorithms performed by these coordination operations are subject to frequent change. That makes it necessary to isolate them in separate objects to be maintained separately.
- In a preliminary draft assign one control object to each use case. Where the situation is more complex, aim for one per actor. The emphasis, as before, is on usefulness of use cases.
- With all these objects we can build up 'use case views' and packages as shown on the next slide...

## Use Case View

- *Model each use case*
- *Describe use case in terms of classes*

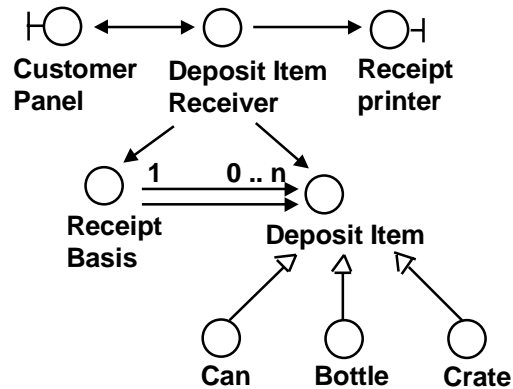

- The next step in the analysis is to take each use case and model it in terms of a class diagram fragment. This is a significant step towards the formalisation of use cases and a test whether all the classes are provided that are needed for the use cases.
- Note that the same class might occur in many different fragments in the same way as the same actors and real world entities occur in different use cases.
- The diagram on this slide shows part model only of objects supporting use case 'Returning item'.
- As a next check we will convince ourselves and any stakeholders that what we have modelled in terms of classes really reflects the real world. This is exemplified on the next slide...





## **An elaborated Use Case**

***When the customer returns a deposit item the Customer Panel's sensors measure its dimensions. These measurements are sent to the control object Deposit Item Receiver which checks via Deposit Item whether it is acceptable. If so, Receipt Basis increments the customer total and the daily total is also incremented. If it is not accepted, Deposit Item Receiver signals this back to Customer Panel which signals NOT VALID.***

***When the Customer presses the receipt button, Customer Panel detects this and sends this message to Deposit Item Receiver. Deposit Item Receiver first prints the date via Receipt Printer and then asks Receipt Basis to go through the customer's returned items and sum them. This information is sent back to Deposit Item Receiver which asks Receipt Printer to print it out.***

© Wolfgang Emmerich, 1998/99

25

- This slide displays the rewriting of the use case we had on the slide before in terms of classes. This is referred to as an elaborated use case.
- This elaborated use case serves three purposes:
  - While performing the exercise of rewriting the use case we double check that every information we had in the previous description is covered in the class diagram.
  - We establish direct links between the use case and the class diagram. This allows tracking user requirements reflected by use cases through the analysis into the design. This traceability is an important basis for analysing the impact of changes to the requirements.
  - Stakeholders would not necessarily be able to understand class diagrams, though they can understand this textual description. Through validating these elaborated use cases they indirectly check the class diagram.
  - The amalgamation of individual parts provided by 'use case views' into one whole requires some kind of modularisation. In UML there are now generic 'packages', which subsume OOSE subsystems. We introduce packages on the next slide...



## ***Packages***

- ***Packages are a way to decompose class diagrams into manageable units***
- ***Packages are necessary:***
  - ***because of large numbers of classes***
  - ***to provide optional functionality***
  - ***to minimise effect of change***

- In real-life projects a sheer amount of classes needs to be handled. Even small scale projects easily have 100 classes and (remember the 7 +/- 2 rule) these cannot be overlooked by humans any more and therefore have to be structured.
- Packages are the language concept offered by the UML for grouping classes. Packages are displayed as a tabbed folder.



## Packages (Cont'd)

### ■ **Packages should have a:**

- *tight functional coupling inside*
- *weak coupling outside indicated by 'dependency associations' between packages*

### ■ **Packages may:**

- *'contain' nested packages with 'service packages' as atomic parts*
- *have individual classes outside*
- *be result of organisational or managerial pressures*

© Wolfgang Emmerich, 1998/99

27

- A package may contain classes and/or nested packages. Classes should be arranged into packages so that there is a tight coupling within the package but a weak coupling in between different packages. Note that the generalisation relationship provides a very very strong coupling and it is therefore useful to arrange for classes that inherit from each other to be in the same package.
- As classes from within one package may need to be associated with classes contained in other packages, the need arises to interface between packages. We therefore use a dependency association between packages. If package A is declared to depend on package B it will be allowed to draw classes contained in B within A. We then note the package from where the class has been referenced together with the class name in the form <package name>::<class name>.
- Packages are useful even in small scale projects, as the recycling machine example shows...

## Recycling Machine Packages

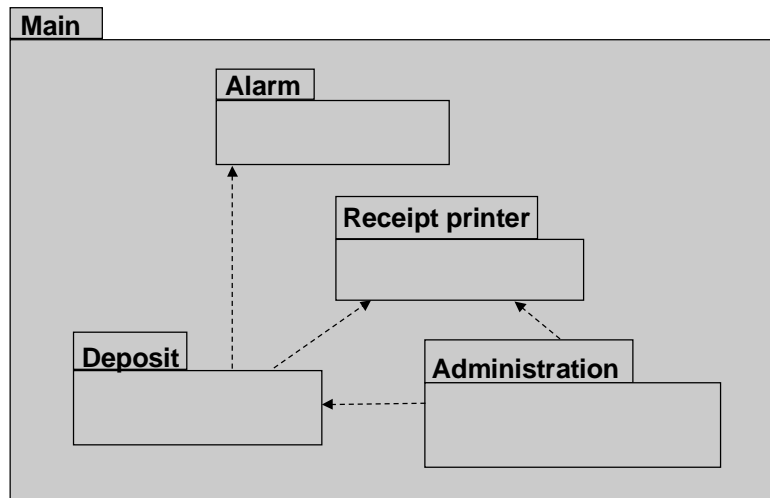

- This slide displays main recycling machine package. As we see, it contains four nested packages: Alarm, Receipt printer, Deposit and Administration.
- The dashed arrows represent dependency associations between packages. The dashed arrows starting from Deposit and leading to Alarm and Receipt printer indicate that Deposit depends on Alarm and Receipt printer. It is therefore valid in Deposit to have references to classes contained in Receipt printer and Alarm.
- The next slide represents the refinement of the 'Deposit' package...

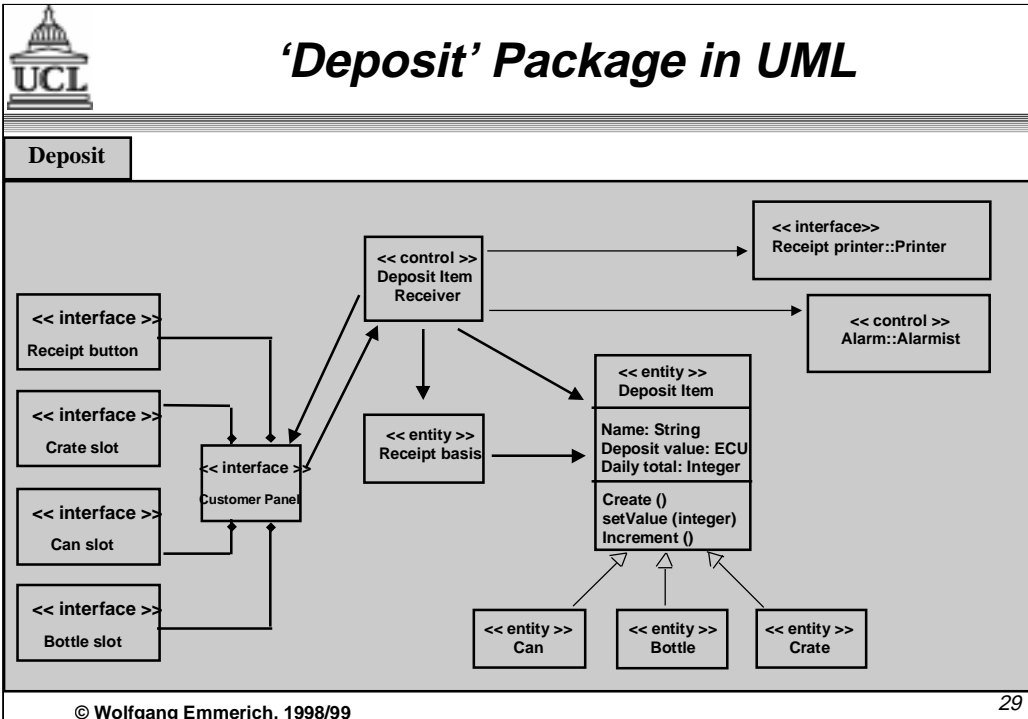

- Note that this diagram details how the Deposit package depends on the other two packages. It includes two so called 'referenced classes'. One is referenced from Receipt printer and another one is referenced from Alarm. Note how the package name is used as a prefix for the class name to indicate that they have been referenced. It then shows the associations between classes of the Deposit package.
- This means that referencing packages can add associations to other classes. In the example above we add an association to the Receipt printer class, for instance. However, packages that reference classes cannot change attributes and operations of the class they reference.



## Analysis Model

### ■ **Outputs:**

- *class roles [text]*
- *use case description in terms of classes and operations [text x use case]*
- *completed analysis model classes [diagram]*
- *sub-system diagrams [package diagram]*

### ■ **Notations introduced:**

- *class, object, associations*
- *(binary, unidirectional, aggregation, generalisation)*
- *stereotypes (classes, associations)*
- *package (+ dependency association)*

© Wolfgang Emmerich, 1998/99

30

- Let us now summarise what we have done during the analysis stage. The analysis model identifies the roles of classes that model the different domain objects that were specified in the requirements model. The analysis model identifies three basic roles that classes can play. These roles guide analysis and make the analysis models more robust to change.
- The second output is the description of use cases in terms of classes and operations. This will be comprised of the text elaborating the use case and the diagrammatic representation of the use case in terms of classes.
- Finally we will have generated a class diagram that is hierarchically organised into packages. The class diagram displays the attributes, operations of each class and the associations the class has with other classes. At higher levels of abstractions, dependency relationships will be specified between packages.



## ***Analysis in OOSE - Summary***

### ■ ***USER PERSPECTIVE***

- ***Actors and Use Cases***
- ***Strong emphasis on requirements modelling***
- ***Resistance to effects of change***

### ■ ***ADVANTAGES OVER OTHER METHODS***

- ***Ways to identify and define classes and objects***
- ***Effective and useful identification of roles of classes***
- ***Recognition of user role (and interface)***
- ***Refined with practical use***

© Wolfgang Emmerich, 1998/99

31

- We have discussed the analysis stage of Jacobson's object-oriented software engineering. It provides techniques such as use cases to enable a methodical basis for identifying objects, unlike other methods. The consequence of employing use cases is the development of user perspectives of the system (improving communication between users and system developers).
- The interface classes integrate the generation of user interfaces into the mainstream method, rather than making it an add-on (as in other approaches).
- The marriage we have presented between OOSE and the UML notation provides a standardised form for outputs, and more specific information (particularly about operations).
- For your background reading we would suggest the following reference:
- [JCJÖ92] Analysis. Chapter 7. pp. 153-200.